

RELOCKED DISTRIBUTION AMPLIFIER with CVS MONITORING 1 SERIAL 4:2:2 INPUT to 6 SERIAL 4:2:2 and 5 PAL/NTSC OUTPUTS

DVD 301/1M

The DVD 301/1M is a high-quality serial 4:2:2 digital video relocked distribution amplifier which provides automatic equalization for up to 250 meters of cable and full regeneration of the signal.

The DVD 301/1M provides 6 x video serial 4:2:2 and 5 x analog PAL / NTSC monitoring outputs.

The DVD 301/1M is designed on an "Europe" 3U electronic board.

Features

- Serial 4:2:2 input
- 6 relocked serial 4:2:2 outputs
- 250 m automatic cable equalization and relocking
- 525/625-line operation
- 5 PAL / NTSC monitoring outputs
- EDH monitoring (option)

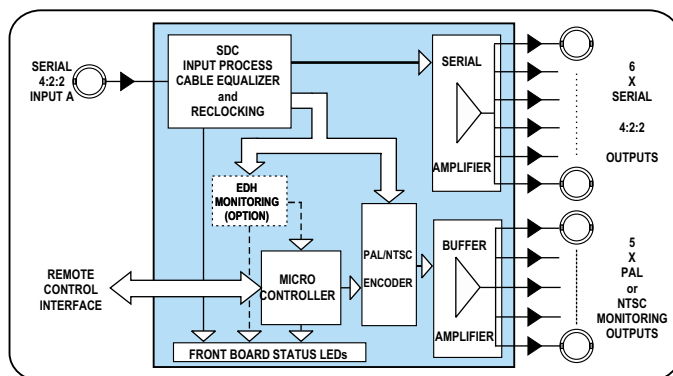

Functional block diagram

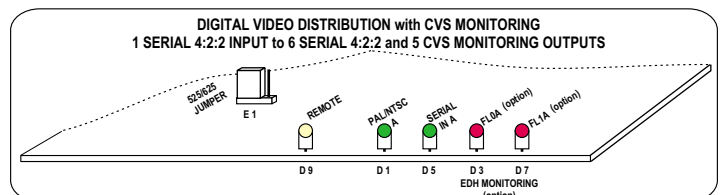

Front edge of the board

User Controls

FRONT PANEL STATUS LEDs

- | | | | |
|-----------------------------|-------------------------------|-------------------|-----------------------------------|
| D 5 : Serial video detected | D 1 : PAL/NTSC encoder status | D 9 : Remote mode | D 3 : FL0 EDH monitoring (option) |
| | | | D 7 : FL1 EDH monitoring (option) |

INTERNAL JUMPER

- E 1 : PAL/NTSC encoder selection

Technical Specifications

INPUT	SERIAL OUTPUTS	PROCESSING PERFORMANCE
SIGNAL : 4:2:2 SMPTE 259M-C (270 Mbit/s)	SIGNAL : 4:2:2 SMPTE 259M-C (270 Mbit/s)	QUANTIZATION : 10 Bit
CABLE LENGTH : > 250 m	RETURN LOSS : >15 dB up to 270 MHz	DELAY : < 10 ns
RETURN LOSS : > 15 dB up to 270 MHz	JITTER : typical value < 500 ps	POWER : 2 W
	CVS OUTPUTS	
	SIGNAL : PAL (625/50) ITU-624-4 or NTSC (525/60) SMPTE 170 M	
	RETURN LOSS : >35 dB up to 5 MHz	

DVD 301/1M

RECLOCKED DISTRIBUTION AMPLIFIER with CVS MONITORING 1 SERIAL INPUT to 6 SERIAL OUTPUTS and 5 PAL/NTSC OUTPUTS

Overall Performances

Serial 4:2:2 input

Standard : SMPTE 259M-C
Nominal signal level : 800 mV
Common
Mode Rejection : 30Vp-p, up to 60Hz
Return loss : >15dB to clock frequency
Equalization : Automatic
Impedance : 75 Ω
Connector : BNC

Serial 4:2:2 outputs

Standard : SMPTE 259M-C
Nominal signal level : 800 mV ± 10%
DC offset : 0V ± 0.5V
Rise and Fall Time : 400-700ps (20 to 80% amplitude)
Return loss : > 15dB to clock frequency
Overshoot : < 10% of amplitude
Impedance : 75 Ω
Connector : BNC

PAL/NTSC monitoring outputs

Standard : PAL (625-50) ITU624-4
NTSC (525-60) SMPTE-170M

Mounting Frames

19" 1RU RACKFRAME

The 19" 1RU rackframe is divided into three identical parts meant to receive the electronic plug-in boards. Each part can hold two 3U Europe plug-in boards with modular rear panel and interconnection. The power supply is incorporated into the mechanical structure. Ventilation of the rack is performed by forced convection. Access is given to electronic plug-in boards by rocking down the front panel.

DIMENSIONS : 1RU x 380 mm deep
WEIGHT : < 5kg

TEMPERATURE RANGE : 0-40°C
ELECTRONIC PLUG-IN BOARDS : up to 6

POWER INPUT RANGE : 97-240 V/50-60 Hz
POWER : 80 W max

1U MODULE REAR PANEL

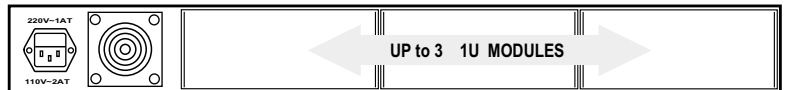
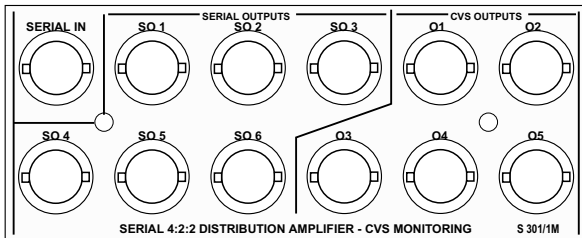

DVD 301/1M
19" 1RU typical
Configurations

3U MODULE REAR PANEL

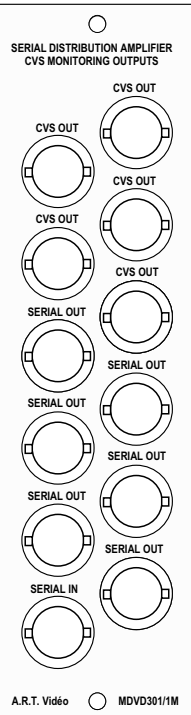

19" 3RU RACKFRAME

The 19" 3RU rackframe holds up to 10 modules with single power supply unit and 9 modules with redundant power supply unit. Access is given to electronic modules by rocking down the front panel. Ventilation of the rack is performed by forced convection. Each module includes : electronic plug-in board, rear interconnection board, and rear mechanical support with the connectors.

DIMENSION : 3RU x 410 mm deep
WEIGHT : < 15 Kg
TEMPERATURE RANGE : 0 - 40°C
ELECTRONIC MODULES : 10 with single power supply
9 with redundant power supply
POWER INPUT : 88 - 135 V or 185 - 264 V (Switchable)
50 / 60 Hz
POWER : 150 W max

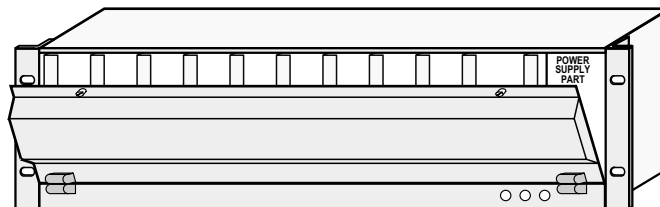
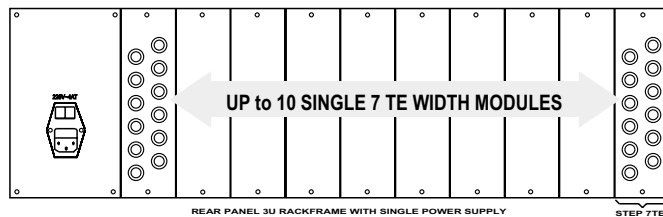

Ordering informations

19" 1RU rackframe

DVD301/1M-S : 19" 1RU rackframe with 1 digital distribution amplifier
DVD301/1M-D : 19" 1RU rackframe with 2 digital distribution amplifiers
DVD301/1M-T : 19" 1RU rackframe with 3 digital distribution amplifiers

B-DVD301/1M : digital distribution amplifier electronic plug-in board

19" 3RU rackframe

M-DVD301/1M : digital distribution amplifier 3U module for 19" 3RU rackframe (Electronic plug-in board and rear panel)

B-DVD301/1M : digital distribution amplifier electronic plug-in board
MOD 3U : rear panel for 19" 3RU rackframe

RACK3U-1 : 19" 3RU rackframe with single power supply

RACK3U-2 : 19" 3RU rackframe with redundant power supply

BPM-1 : blank rear panel unit

Specifications and designs are subject to change without notice